

Rockwell Unscripted® Creative Wall® Post

Pattern Numbers Represented:
Unscripted Borders Post, **UBCP90_**

Part List:

- (A) Post Segment
- (B) Post Spacer
- (C) Castle Bracker
- (D) Beam Spacer
- (E) Under-Beam Post Cover
- (F) Full-Height Post Cover
- (G) 1/4-20 x 1-3/4" Hex Head Screw
- (H) 1/4-20 x 1" Button Head Screw
- (I) 1/4-20 x 1-1/2" Button Head Screw
- (J) 1/4-20 x 1/2" Button Head Screw
- (K) Enclosure Beam End Bracker
- (L) Nut Plate

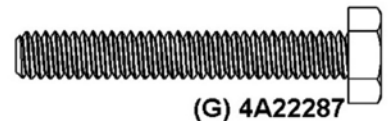
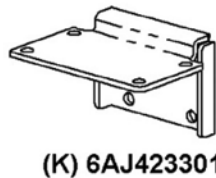
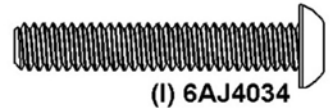
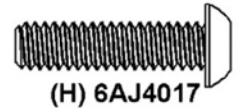
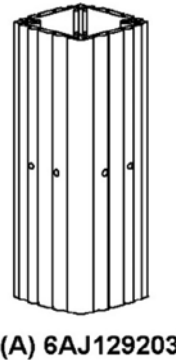
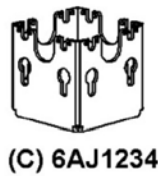
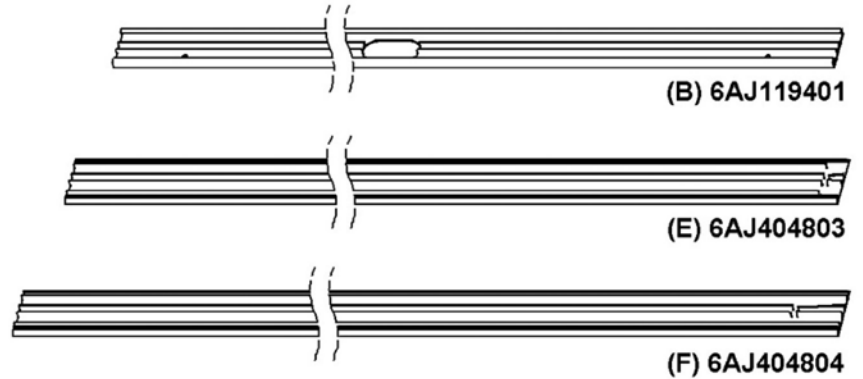

DISASSEMBLY FOR RECYCLING

Materials Identification and Segregation:

Where possible plastic components are marked with ASTM recycling codes. Use these codes to identify material type for recycling. Non-marked components should be treated as mixed plastic. Ferrous metals can be identified using a small magnet for recycling. Non-ferrous metals should be separated and recycled separately.

To disassemble product, reverse the above installation steps.

Rockwell Unscripted® Creative Wall® Post, continued

Notes:

- Posts are used at corners with various combinations of walls and beams. The following illustrations show one example. The procedure can be applied to any combination of corner conditions. The appropriate components and hardware are provided for the pattern number specified.
- At least 1 wall is required at the intersection.
- Posts should be installed before any Vertical Surfaces are installed to the Wall Frames.
- If Beams are to be mounted to the post, supporting structure for the far end of the beams must be in place. Both ends of the Beam must be installed simultaneously.
- In configurations with 3 or 4 Wall Frames, it is suggested that any electrical jumpers be routed through the post before the third or fourth walls are installed to the Post.

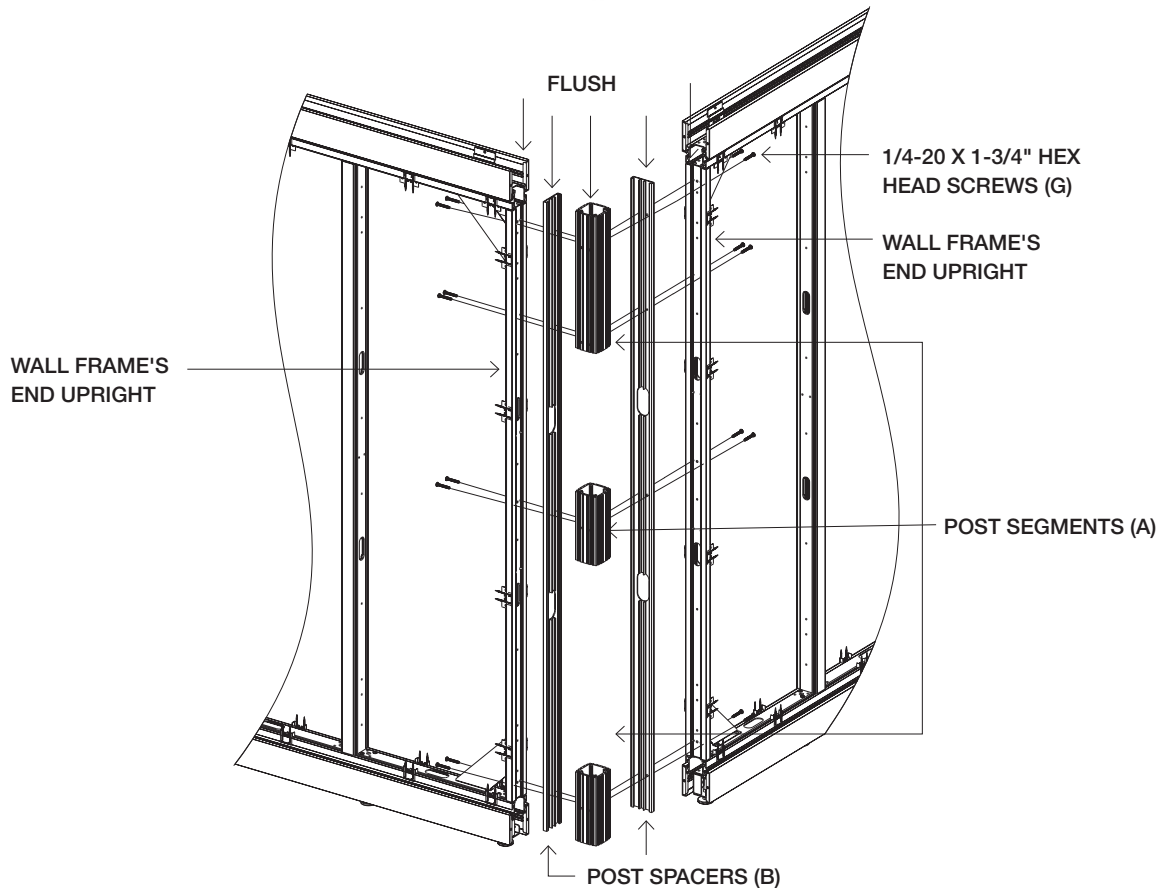
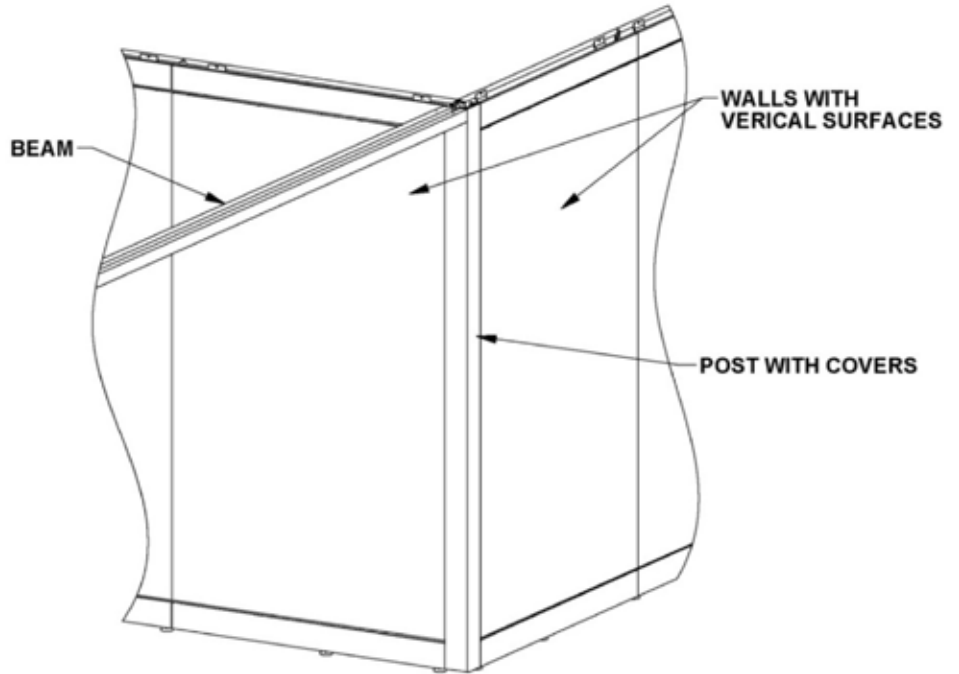

Rockwell Unscripted® Creative Wall® Post, continued

1. Position (1) Post Spacer (B) against the End Upright of the Wall Frame. The Post Spacer (B) has 2 ribs which align it with the End Upright. Locate it so that the top of the Post Spacer (B) is flush with the top of the Wall Frame's Upper Horizontal.

2. Install (3) Post segments (A) to the first Wall Frame using (2) 1/4-20 x 1-3/4" Hex Head Screws (G) through the End Upright, through the Post Spacer (B) and into the threaded holes of each Post Segment (A). Use the same pair of holes in the End Upright that are used when joining inline wall frames.

Note: For stability, the first Wall Frame should be initially supported by Feet or joined to a perpendicular Wall Frame.

3. Align and level any remaining Wall Frames specified for the Post. Install by following the same procedure described in Step 2. If no additional Wall Frames are required, proceed to Step 4.

4. If Beams are specified for the Post, install (1) Castle Bracket (C) to the upper Post Segment (M) using (8) 1/4 x 1" Button Head Screws (H).

Note: Any combination of Standard Beams and Enclosure Beams can be installed to the open sides of the Post. Follow Step 5 for the Standard Beam installation and Step 6 for the Enclosure Beam.

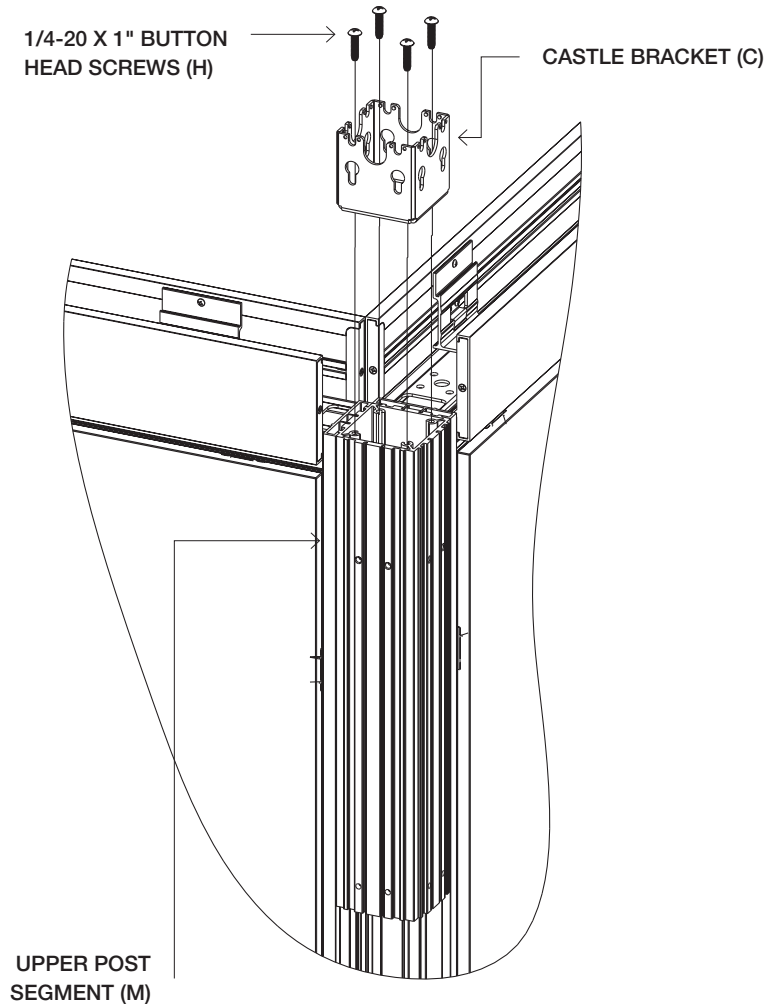

Rockwell Unscripted® Creative Wall® Post, continued

Standard Beam installation to Post:

Beam installation requires assembly of both ends of the Beam simultaneously so that both ends of the beam are supported. At least 2 people are required.

1. Start (4) 1/4-20 x 1-1/2" Button Head Screws (I) into the 4 tapped holes in the end of the Beam.

Note: The 1/4-20 x 1-1/2" Button Head Screws (I) should extend beyond the end face of the Beam with a 3/4" to 1" gap between the Beam and the underside of the screw heads.

2. While holding the Beam Spacer (D) against the end face of the Castle Bracket (C), bring the (4) extended 1/4-20 x 1-1/2" Button Head Screws (I) installed in the Beam through the keyholes in the Beam Spacer (D) and Castle Bracket (C). Let the extended screws rest at the bottom of the keyhole.

Note: The back of the Beam Spacer (D) has an alignment pin which engages into a hole on the Castle Bracket (C)

3. Tighten the (4) 1/4-20 x 1-1/2" Button Head Screws (I) while lifting & aligning the Beam Spacer (D) with the Beam and the Castle Bracket (C).

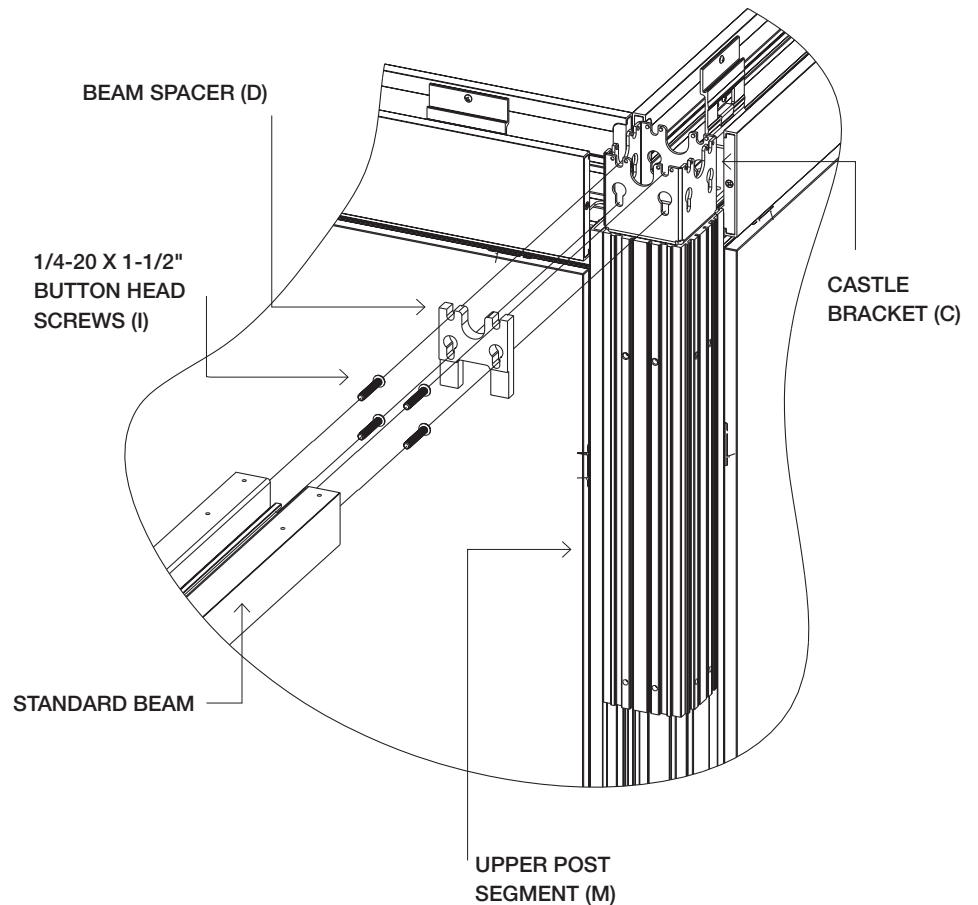

Rockwell Unscripted® Creative Wall® Post, continued

Standard Beam installation to Post:

Beam installation requires assembly of both ends of the Beam simultaneously so that both ends of the beam are supported. At least 2 people are required.

1. Install the Enclosure Beam End Bracket (K) to the Enclosure Beam using (4) 1/4-20 x 1" Button Head Screws (H) into tapped holes on the top surface of the Enclosure Beam.
2. Insert (4) 1/4-20 x 1/2" Button Head screws (J) through the side of the Enclosure Beam End Bracket (K) and start them into the threaded inserts of the Nut Plate (L). Leave the screws loose enough that the heads extend out at least 1/8" from the bracket.
3. Bring the extended heads of the screws through the keyholes in the Castle Bracket (C) and let the extended screws rest at the bottom of the keyholes.
4. Tighten the (4) 1/4-20 x 1/2" Button Head Screws (J).

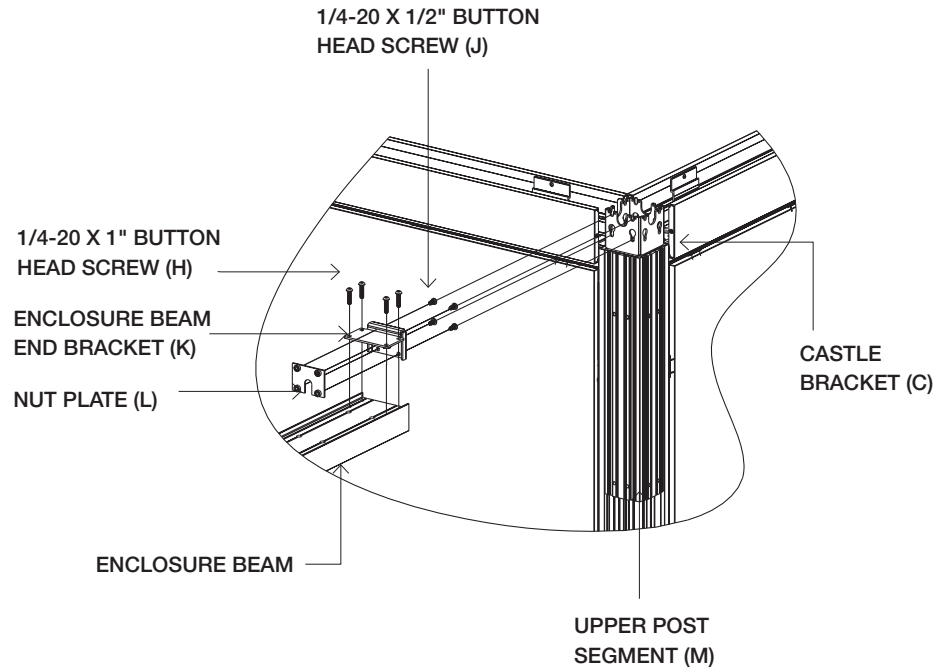

Rockwell Unscripted® Creative Wall® Post, continued

Install the vertical Post Covers:

There are 2 types of Post Covers: Under-Beam Post Cover (E) and Full-Height Post Cover (F). Each has formed tabs on the back upper end which will rest on the upper Post Segment (A). Each Post Cover also has an interlocking detail which aligns with the adjacent covers and blocks light.

1. Position the Under-Beam Post Cover (E) directly under and against the bottom side of the Beam. The short formed tabs are to rest on the top of the upper Post Segment (A). Snap the cover onto each Post Segment (A).







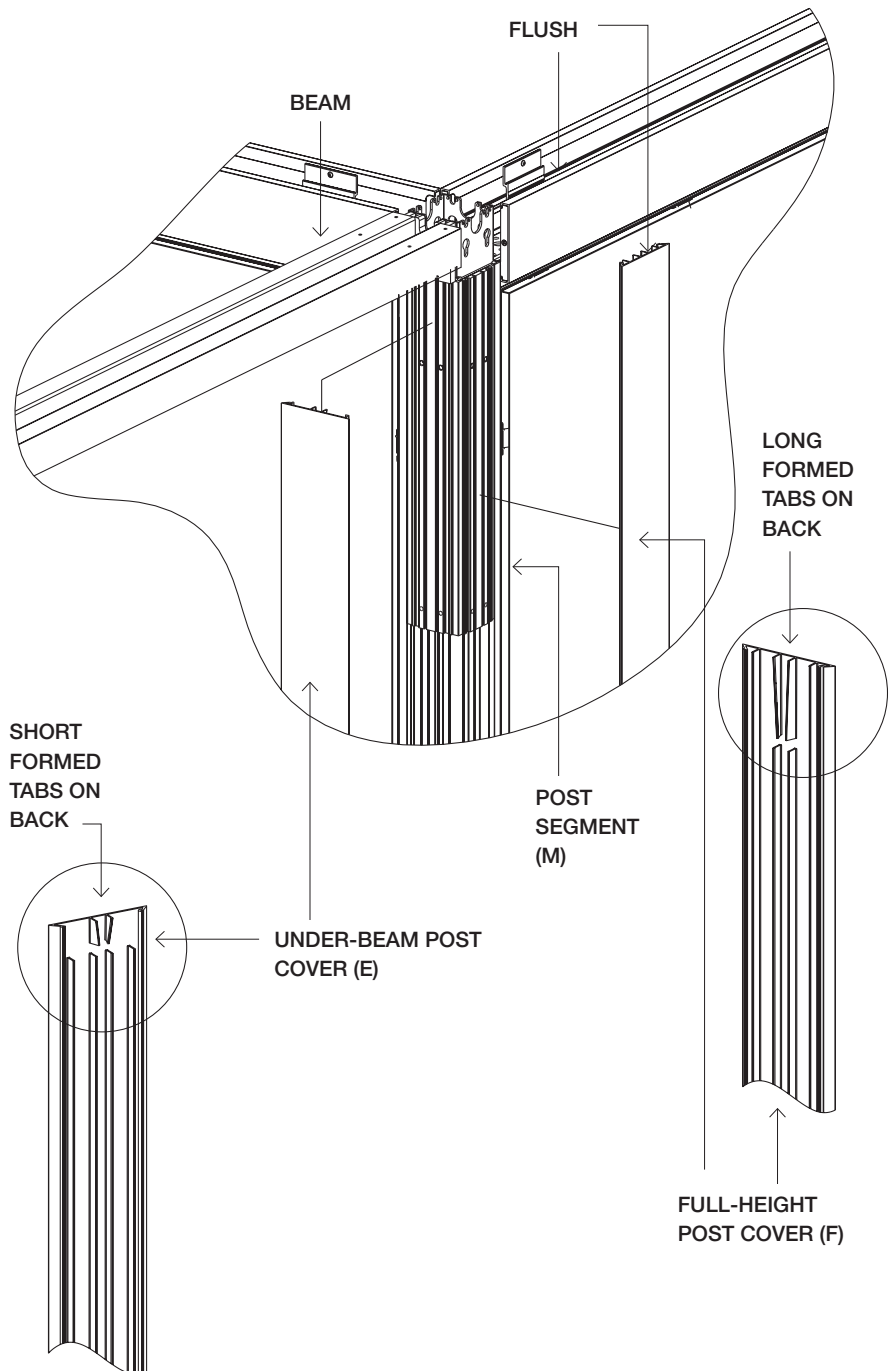

2. Position the Full-Height Post Covers (F) on sides which do not have a Beam or a Wall Frame attached. Rest the long formed tabs on the top of the upper Post Segment (A) and snap the cover onto each Post Segment (A) using a rubber mallet if necessary.

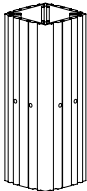
Note: The Full-Height Post Covers (E) will align with the top of the adjacent Beam and with the top of Horizontal Trims installed on adjacent Wall Frames.

3. Ensure that all Post Covers (E & F) are aligned and properly engaged (use a rubber mallet if necessary) along each vertical joint.

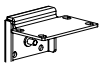

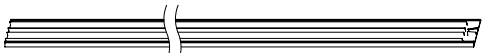
Rockwell Unscripted® Creative Wall® Post, continued

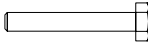
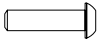
Description	Reference*	Replacement Pattern Number
Post extrusion segment 	6AJ129203 6AJ129204	KR6AJ129203 Includes: 6AJ129203 - qty 1 KR6AJ129404
Wall post spacer 	6AJ119401	KR6AJ119401 Includes: 6AJ119401 - qty 1
Castle bracket 	6AJ1234	KR6AJ1234 HLKR6AJ1234 24 - Response Includes: 6AJ1290 - qty 1
Beam spacer, in-line 	6AJ1135	KR6AJ1135 HLKR6AJ1135 24 - Response Includes: 6AJ1135 - qty 1
Bracket weldment, enclosure beam to end bracket 	6AJ4233	KR6AJ4233 Includes: 6AJ4233 - qty 1
Nut plate, enclosed beam castle bracket 	6AJ4244	KR6AJ4244 Includes: 6AJ244 - qty 1
Universal post cover, under beam 	6AJ404803	KR6AJ404803() Includes: 6AJ404803() - qty 1
Universal post cover, full height 	6AJ404804	KR6AJ404804() Includes: 6AJ404804() - qty 1
Bolt, hex head, 1/4-20 x 1.75", zinc 	4A22287	KR4A22287 HLKR4A22287 24 - Response Includes: 4A22287 - qty 1
Screw button head, hex drive, 1/4-20 x 1", black, with lockpatch 	6AJ4017	KR6AJ4017 HLKR6AJ4017 24 - Response Includes: 6AJ4017 - qty 1

General Notes

1. "HL" and "ZZ" prefix in pattern number denotes 24-Response. Part will be shipped within 24-hours via ground service, pending availability; quantity limits and higher pricing apply.
2. See the product Price Lists on www.Knoll.com for material, textile, and finish options denoted by ().
3. *Not offered as an orderable service part number.